

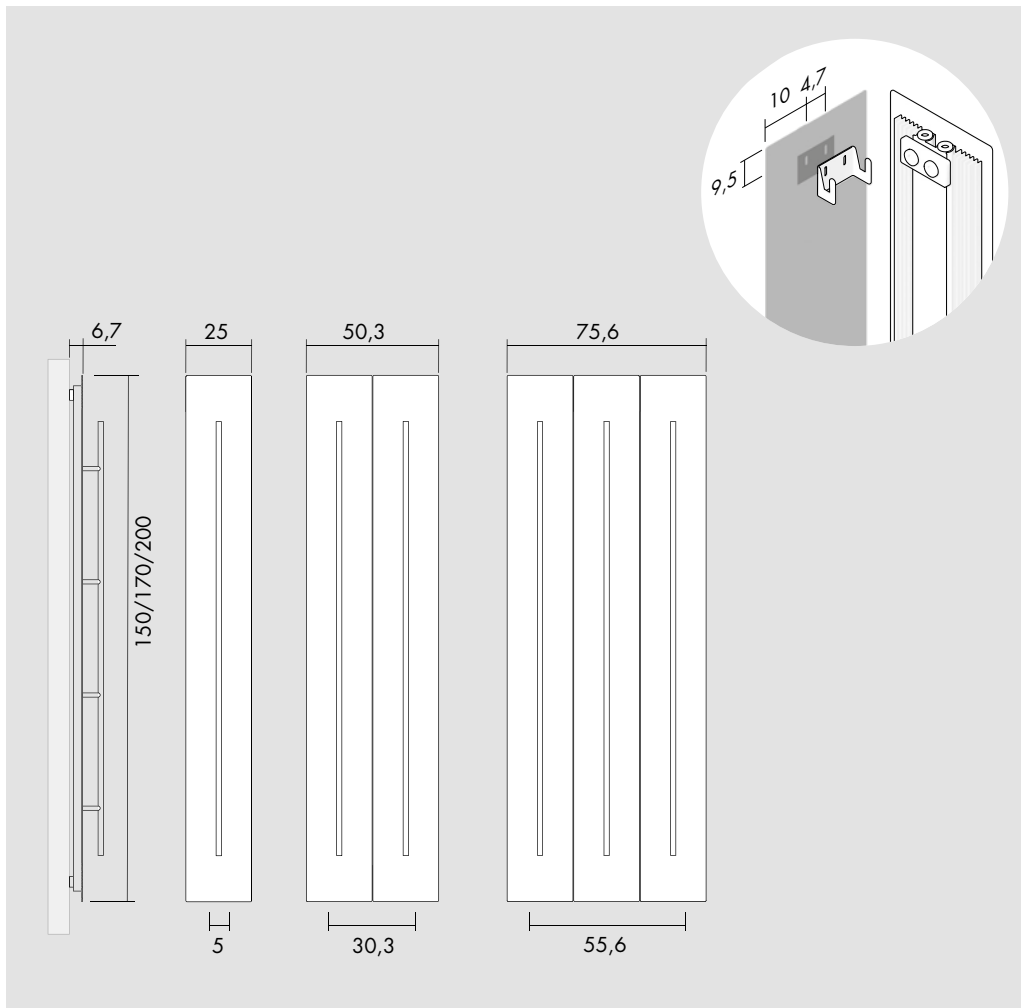

Kcal = Watt x 0.860  
BTU = Watt x 3.413

Watt  $\Delta t$  60° = Watt  $\Delta t$  50° x 1.286  
Watt  $\Delta t$  40° = Watt  $\Delta t$  50° x 0.735  
Watt  $\Delta t$  30° = Watt  $\Delta t$  50° x 0.495  
Watt  $\Delta t$  20° = Watt  $\Delta t$  50° x 0.283

p max = 5.0 bar



## [F]

Standard connection / Raccord standard  
Standard Anschluss / Conexión estándar

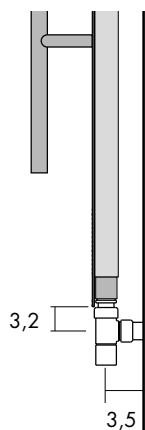

## [H]

Special connection / Raccord spéciale / Speziell Anschluss / Conexión especial

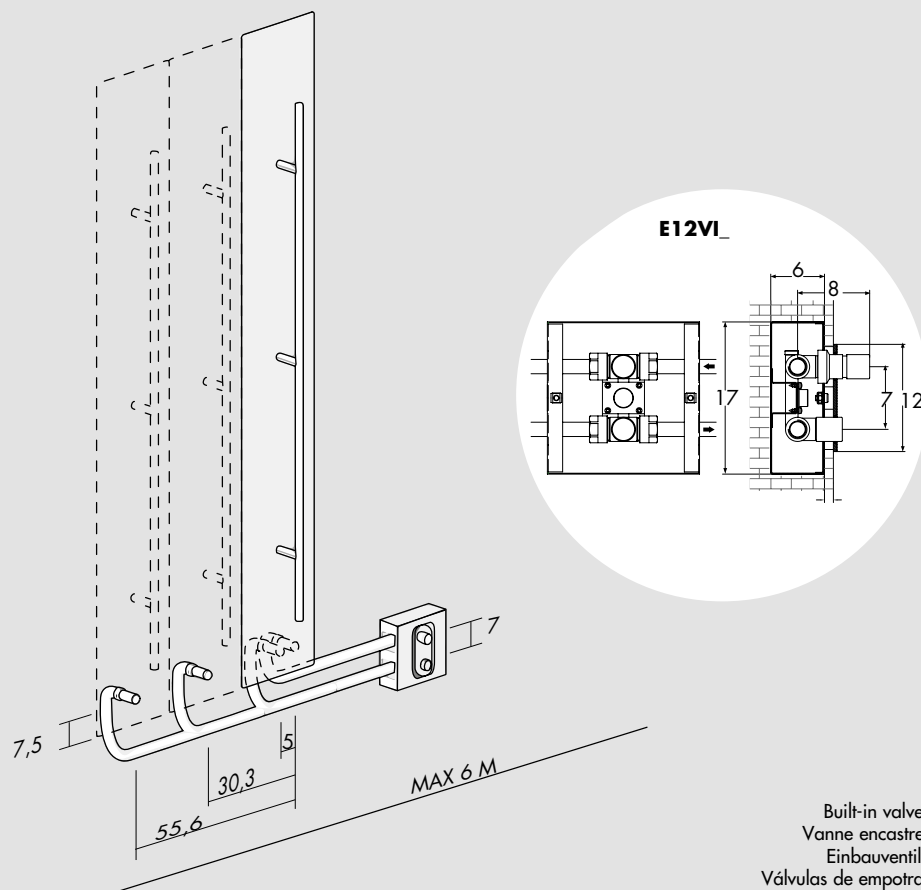

Built-in valves  
Vanne encastrer  
Einbauventile  
Válvulas de empotrar

## Teso V

H cm	L cm	l* cm	art*	Lt*	watt $\Delta t$ 30°	watt $\Delta t$ 50°
150.0	25.0	5.0	<b>TSV150001_</b>	1.1	192	<b>388</b>
150.0	50.3	30.3	<b>TSV150002_</b>	2.3	384	<b>776</b>
150.0	75.6	55.6	<b>TSV150003_</b>	3.5	576	<b>1 164</b>
170.0	25.0	5.0	<b>TSV170001_</b>	1.2	213	<b>431</b>
170.0	50.3	30.3	<b>TSV170002_</b>	2.5	427	<b>862</b>
170.0	75.6	55.6	<b>TSV170003_</b>	3.9	640	<b>1 293</b>
200.0	25.0	5.0	<b>TSV200001_</b>	1.4	251	<b>507</b>
200.0	50.3	30.3	<b>TSV200002_</b>	2.9	502	<b>1 014</b>
200.0	75.6	55.6	<b>TSV200003_</b>	4.4	753	<b>1 521</b>

## Teso V CRSM

Aluminium radiator sanded by hand  
 Radiateur en aluminium poncé à la main  
 Heizkörper aus Aluminium von Hand polierter Edelplatte  
 Radiador en aluminio pulido artesanalmente

H cm	L cm	l* cm	art*	Lt*	watt $\Delta t$ 30°	watt $\Delta t$ 50°
150.0	25.0	5.0	<b>TSV150001_</b>	1.1	192	<b>388</b>
150.0	50.3	30.3	<b>TSV150002_</b>	2.3	384	<b>776</b>
150.0	75.6	55.6	<b>TSV150003_</b>	3.5	576	<b>1 164</b>
170.0	25.0	5.0	<b>TSV170001_</b>	1.2	213	<b>431</b>
170.0	50.3	30.3	<b>TSV170002_</b>	2.5	427	<b>862</b>
170.0	75.6	55.6	<b>TSV170003_</b>	3.9	640	<b>1 293</b>
200.0	25.0	5.0	<b>TSV200001_</b>	1.4	251	<b>507</b>
200.0	50.3	30.3	<b>TSV200002_</b>	2.9	502	<b>1 014</b>
200.0	75.6	55.6	<b>TSV200003_</b>	4.4	753	<b>1 521</b>

**R = CRSM** Brushed chrome / Chrome brossé / Gebürstet Chrome / Cromo cepillado

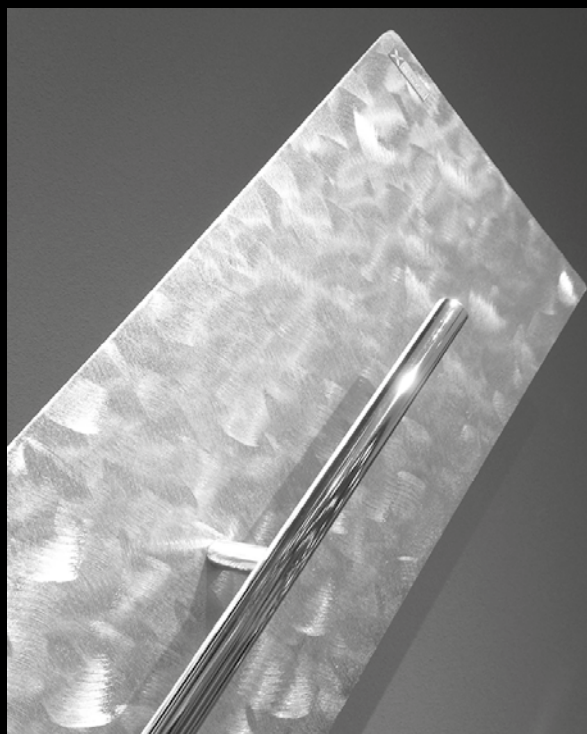

## Optional



Reverse Valve  
 Vanne reverse  
 Reverse Ventil  
 Válvula a escuadra inversa

[BIAN] **E12RVB**  
 [CROM] **E12RVB**

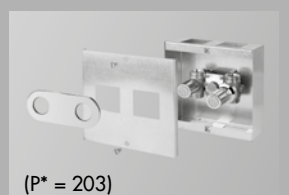

Built-in valves  
 Vanne encastrer  
 Einbauventile  
 Válvulas de empotrar

[BIAN] **E12VIB**  
 [CROM] **E12VIR**



Thermostatic head  
 Tête thermostatique  
 Thermostatkopf  
 Cabezal termostático

[BIAN] **VTTB**  
 [CROM] **VTTR**

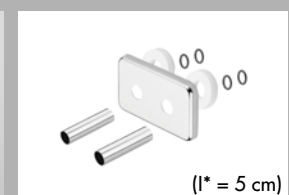

Sleeving kit  
 Kit couvre tuyau  
 Rosetten  
 Kit cubre tubo

[BIAN] **C5B**  
 [CROM] **C5R**

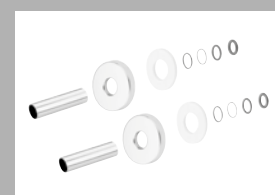

$\varnothing \leq 16$  mm  
 [BIAN] **CTB**  
 [CROM] **CTR**

$16 \text{ mm} < \varnothing < 24$  mm  
 [BIAN] **CWB**  
 [CROM] **CWR**



Towel bar  
 Porte-serviettes  
 Handtuchhalter  
 Porta toallas

**Teso 1**  
 [COLOUR] **STC1**  
 [GOLD] **STG1**

**Teso 2**  
 [COLOUR] **STC2**  
 [GOLD] **STG2**

**Teso 3**  
 [COLOUR] **STC3**  
 [GOLD] **STG3**

**art\*** = item / modèle / Artikel / artículo    **l\*** = pipe centres / distance entre depart et retour / Achsabstand / distancia entre las conexiones  
**Lt\*** = water content for each element / volume d'eau pour chaque element / Wassergehalt für Element / contenido de agua por cada elemento  
**P\*** = page / page / Seite / página



Kcal = Watt x 0.860  
BTU = Watt x 3.413

Watt  $\Delta t$  60° = Watt  $\Delta t$  50° x 1.252  
Watt  $\Delta t$  40° = Watt  $\Delta t$  50° x 0.759  
Watt  $\Delta t$  30° = Watt  $\Delta t$  50° x 0.532  
Watt  $\Delta t$  20° = Watt  $\Delta t$  50° x 0.323

p max = 6.5 bar

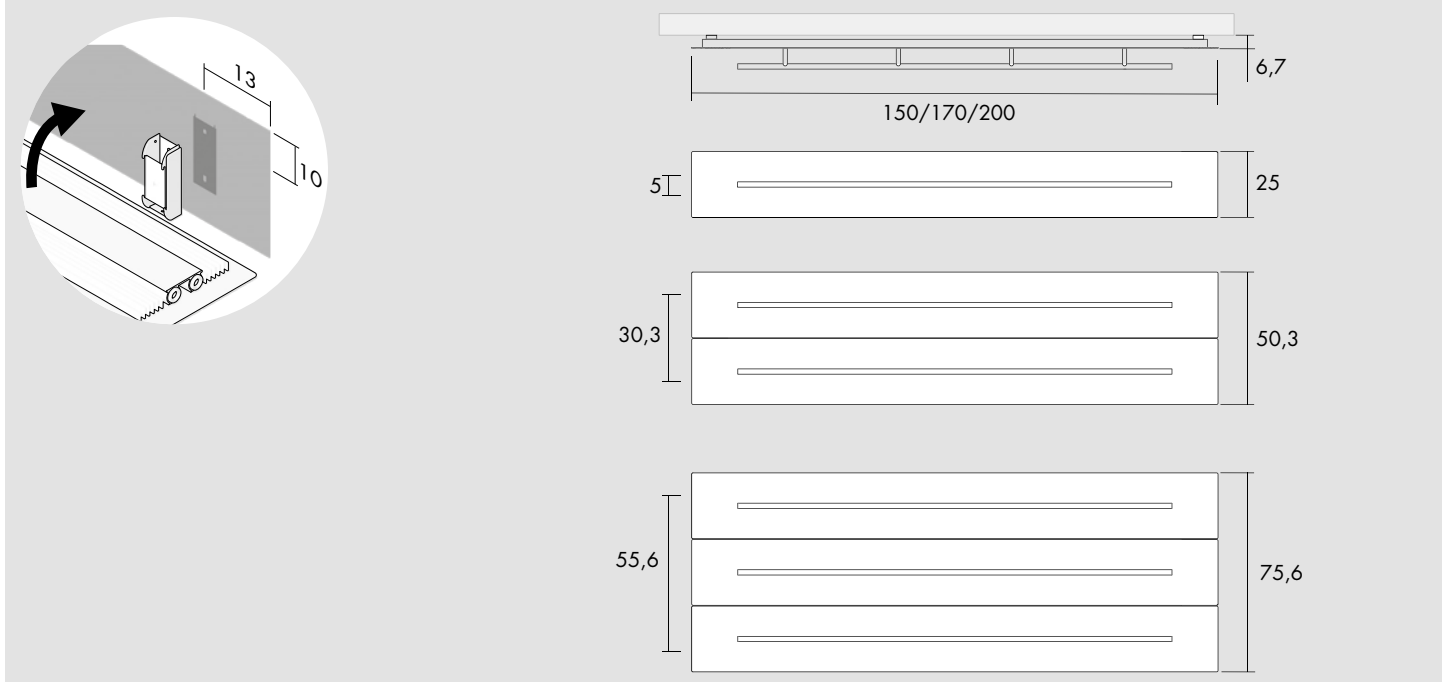

## [F]

Standard connection / Raccord standard  
Standard Anschluss / Conexión estándar

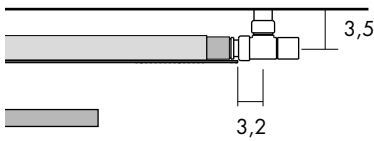

## [H]

Special connection / Raccord spéciale / Speziell Anschluss / Conexión especial

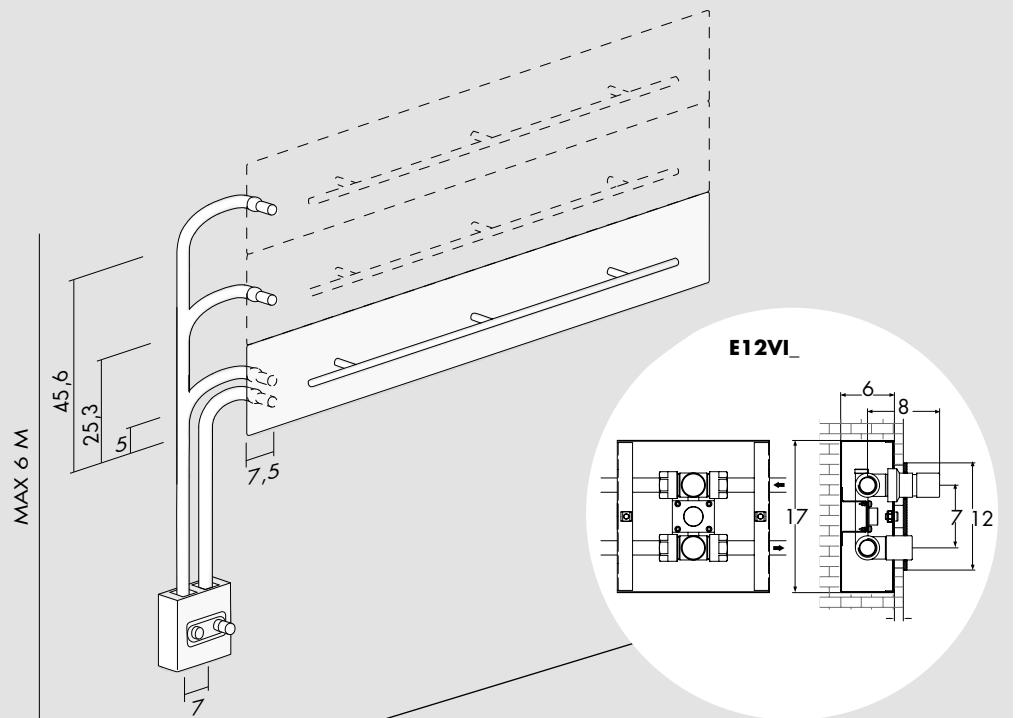

Built-in valves  
Vanne encastrer  
Einbauventile  
Válvulas de empotrar

## Teso O

H cm	L cm	l* cm	art*	Lt*	watt $\Delta t$ 30°	watt $\Delta t$ 50°
25.0	150.0	5.0	<b>TSO150001_</b>	1.1	182	<b>343</b>
50.3	150.0	30.3	<b>TSO150002_</b>	2.3	365	<b>687</b>
75.6	150.0	55.6	<b>TSO150003_</b>	3.5	548	<b>1 030</b>
25.0	170.0	5.0	<b>TSO170001_</b>	1.2	207	<b>390</b>
50.3	170.0	30.3	<b>TSO170002_</b>	2.5	415	<b>781</b>
75.6	170.0	55.6	<b>TSO170003_</b>	3.9	623	<b>1 171</b>
25.0	200.0	5.0	<b>TSO200001_</b>	1.4	244	<b>459</b>
50.3	200.0	30.3	<b>TSO200002_</b>	2.9	488	<b>918</b>
75.6	200.0	55.6	<b>TSO200003_</b>	4.4	733	<b>1 377</b>

## Teso O CRSM

Aluminium radiator sanded by hand  
 Radiateur en aluminium poncé à la main  
 Heizkörper aus Aluminium von Hand polierter Edelpolierplatte  
 Radiador en aluminio pulido artesanalmente

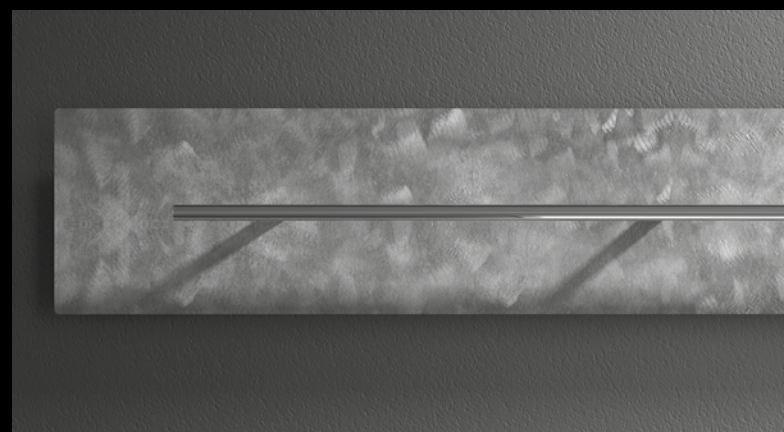

H cm	L cm	l* cm	art*	Lt*	watt $\Delta t$ 30°	watt $\Delta t$ 50°
25.0	150.0	5.0	<b>TSO150001_</b>	1.1	182	<b>343</b>
50.3	150.0	30.3	<b>TSO150002_</b>	2.3	365	<b>687</b>
75.6	150.0	55.6	<b>TSO150003_</b>	3.5	548	<b>1 030</b>
25.0	170.0	5.0	<b>TSO170001_</b>	1.2	207	<b>390</b>
50.3	170.0	30.3	<b>TSO170002_</b>	2.5	415	<b>781</b>
75.6	170.0	55.6	<b>TSO170003_</b>	3.9	623	<b>1 171</b>
25.0	200.0	5.0	<b>TSO200001_</b>	1.4	244	<b>459</b>
50.3	200.0	30.3	<b>TSO200002_</b>	2.9	488	<b>918</b>
75.6	200.0	55.6	<b>TSO200003_</b>	4.4	733	<b>1 377</b>

**R = CRSM** Brushed chrome / Chrome brossé  
 Gebürstet Chrome / Cromo cepillado

## Optional



Reverse Valve  
 Vanne reverse  
 Reverse Ventil  
 Válvula a escuadra inversa

[BIAN] **E12RVB**  
 [CROM] **E12RVB**

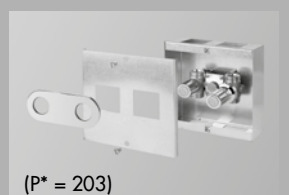

Built-in valves  
 Vanne encastrer  
 Einbauventile  
 Válvulas de empotrar

[BIAN] **E12VIB**  
 [CROM] **E12VIR**



Thermostatic head  
 Tête thermostatique  
 Thermostatkopf  
 Cabezal termostático

[BIAN] **VTTB**  
 [CROM] **VTTR**

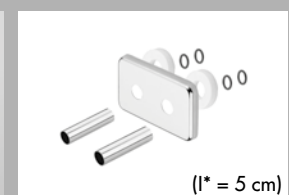

Sleeving kit  
 Kit couvre tuyau  
 Rosetten  
 Kit cubre tubo

[BIAN] **C5B**  
 [CROM] **C5R**

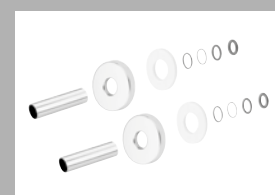

$\varnothing \leq 16$  mm  
 [BIAN] **CTB**  
 [CROM] **CTR**

$16 \text{ mm} < \varnothing < 24$  mm  
 [BIAN] **CWB**  
 [CROM] **CWR**



Towel bar  
 Porte-serviettes  
 Handtuchhalter  
 Porta toallas

**Teso 1**  
 [COLOUR] **STC1**  
 [GOLD] **STG1**

**Teso 2**  
 [COLOUR] **STC2**  
 [GOLD] **STG2**

**Teso 3**  
 [COLOUR] **STC3**  
 [GOLD] **STG3**

**art\*** = item / modèle / Artikel / artículo    **l\*** = pipe centres / distance entre depart et retour / Achsabstand / distancia entre las conexiones  
**Lt\*** = water content for each element / volume d'eau pour chaque element / Wassergehalt für Element / contenido de agua por cada elemento  
**P\*** = page / page / Seite / página

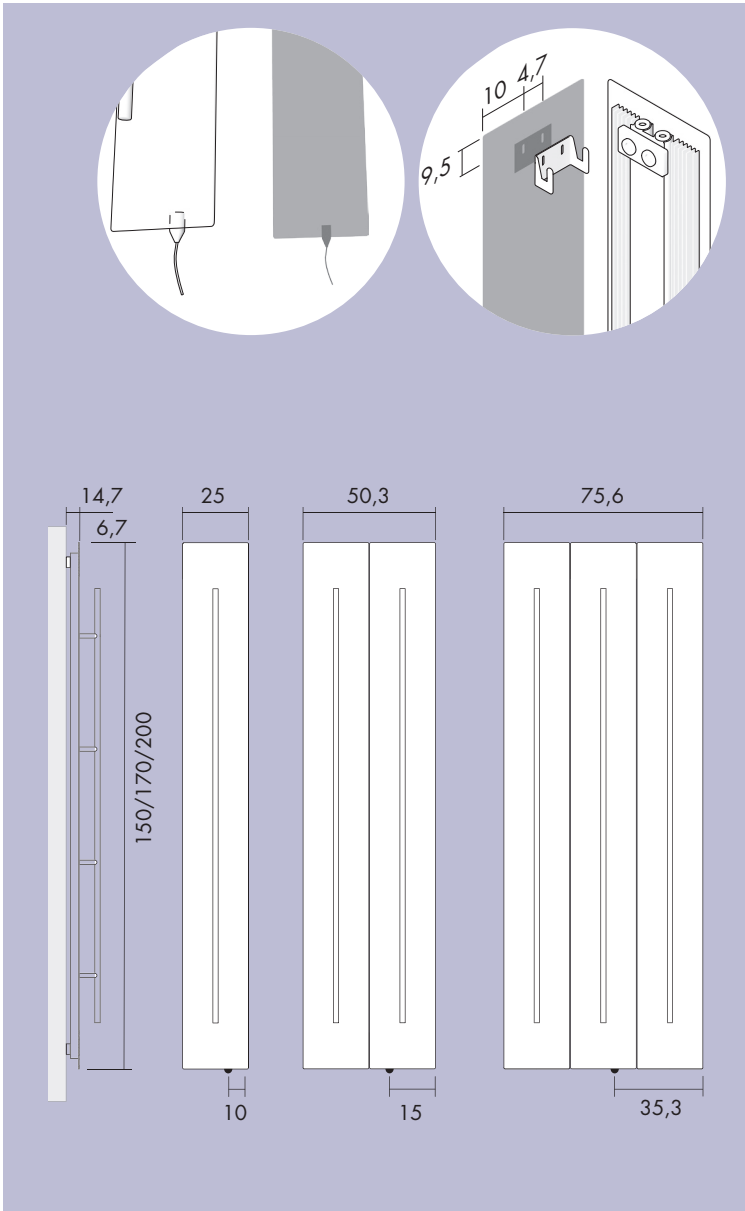

H cm	L cm	art*	watt	watt	CROM [ R ]
150.0	25.0	EC TSV150001_	200	200	
150.0	50.3	EC TSV150002_	500	500	
150.0	75.6	EC TSV150003_	700	700	
170.0	25.0	EC TSV170001_	250	250	
170.0	50.3	EC TSV170002_	600	600	
170.0	75.6	EC TSV170003_	700	700	
200.0	25.0	EC TSV200001_	300	300	
200.0	50.3	EC TSV200002_	700	700	
200.0	75.6	EC TSV200003_	900	900	

**R = CRSM**  
 Brushed chrome / Chrome brossé /  
 Gebürstet Chrome / Cromo cepillado

Optional



Receiver  
 Récepteur  
 Empfänger  
 Receptor

**R10**



Digital chronothermostat  
 Chronothermostat digital  
 Der digital Chronothermostat  
 Cronotermostato digital

**T10**

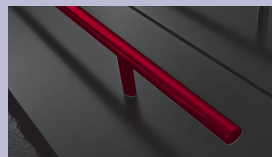

Towel bar  
 Porte-serviettes  
 Handtuchhalter  
 Porta toallas

**Teso 1**  
 [COLOUR] **STC1**  
 [GOLD] **STG1**

**Teso 2**  
 [COLOUR] **STC2**  
 [GOLD] **STG2**

**Teso 3**  
 [COLOUR] **STC3**  
 [GOLD] **STG3**